

# HOME THEATER SOUND SYSTEM SYSTEME HOME CINEMA

## TSS-15

(Amplifier x 1, Front/Center speaker x 3, Surround speaker x 2, Subwoofer x 1)

**CinemaStation**

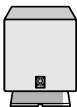
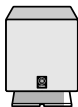
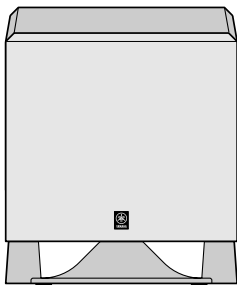
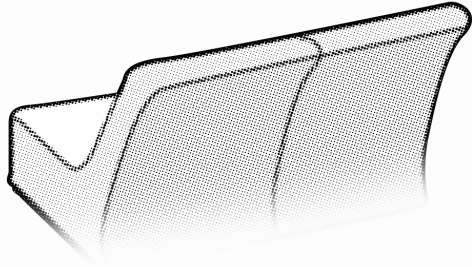
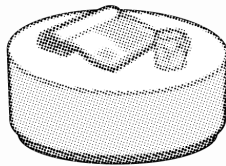
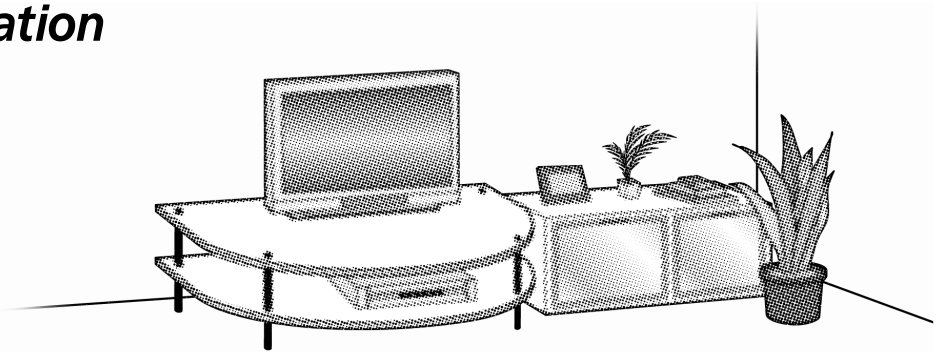

**OWNER'S MANUAL  
MODE D'EMPLOI**

# CAUTION: READ THIS BEFORE OPERATING YOUR SYSTEM.

- 1 To assure the finest performance, please read this manual carefully. Keep it in a safe place for future reference.
- 2 Install this sound system in a well ventilated, cool, dry, clean place with at least 20 cm on top, 10 cm on the left and right, and 10 cm at the back of the amplifier unit — and away from direct sunlight, heat sources, vibration, dust, moisture, and/or cold.
- 3 Locate this system away from other electrical appliances, motors, or transformers to avoid humming sounds. To prevent fire or electrical shock, do not place this system where it may be exposed to dripping or splashing, and never put any objects filled with liquids, such as vases, on top of the system.
- 4 Do not expose this system to sudden temperature changes from cold to hot. Do not locate this system in an environment with high humidity (i.e., a room with a humidifier) to prevent condensation inside this system, which may cause electrical shock, fire, damage to this system, and/or personal injury.
- 5 Avoid installing this system in a place where foreign objects or liquid might fall. Otherwise, fire, damage to the system, and/or personal injury may result. Do not place the following objects on this system:
  - Other components, as they may cause damage and/or discoloration of the surface of the system.
  - Burning objects (i.e., candles) as they may cause fire, damage to the system, and/or personal injury.
  - Containers of liquid, as they may leak or spill and cause electrical shock to the user and/or damage to this system.
- 6 Do not cover this system with a newspaper, tablecloth, curtain, etc. in order not to obstruct heat radiation. If the temperature inside this system rises, it may result in fire, damage to the system, and/or personal injury.
- 7 Do not plug this system into a wall outlet until all connections are complete.
- 8 Do not operate this system upside-down. It may overheat, possibly causing damage.
- 9 Do not use excessive force on switches, knobs, and/or cables.
- 10 When disconnecting the power cable from a wall outlet, grasp the plug; do not pull the cable.
- 11 Do not clean this system with chemical solvents; they might damage the finish. Use a clean, dry cloth.
- 12 Only the voltage specified on this system may be used. Using this system with a voltage higher than specified is dangerous and may cause fire, damage to the system, and/or personal injury. YAMAHA will not be held responsible for any damage resulting from use of this system with a voltage other than specified.
- 13 To prevent damage by lightning, disconnect the power cable from the wall outlet during an electrical storm.
- 14 Take care of this system to prevent foreign objects and/or liquid drops from entering the system.
- 15 When using a humidifier, avoid condensation inside the system by allowing sufficient space around the system. Avoid excess humidification. Condensation might cause a fire, damage to the system, and/or electric shock.
- 16 Do not attempt to modify or fix this system. Contact qualified YAMAHA service personnel when any service is needed. The cabinet should never be opened for any reason.
- 17 When not planning to use this system for a long period of time (i.e., vacation), disconnect the AC power plug from the wall outlet.
- 18 Be sure to read the “Troubleshooting” section for information on common operating errors before concluding that this system is faulty.

- 19 Before moving this system, press STANDBY/ON to place the system in standby mode, and disconnect the AC power plug from the wall outlet.
- 20 Be sure to only use the AC adaptor (LSE9802B1540) included with this system. Otherwise, you might cause a fire or damage to this system.

- This system is not fully disconnected from the AC power source as long as it is connected to a wall outlet, even if the system is turned off. This state is called Standby mode. In Standby mode, the system consumes a very small amount of power.
- Do not install the system in a horizontal orientation as this may cause damage or malfunction.
- This system is designed for use in a home. Do not attempt to install it in an automobile. Doing so may cause damage or malfunction.

## WARNING

TO REDUCE THE RISK OF FIRE OR ELECTRIC SHOCK, DO NOT EXPOSE THIS APPLIANCE TO RAIN OR MOISTURE.

## ■ For U.K. customers

If the socket outlets in the home are not suitable for the plug supplied with this appliance, the plug should be removed and an appropriate 3-pin plug fitted. For details, refer to the instructions below.

### Note

A plug severed from the mains lead must be destroyed, as a plug with bared flexible cord is hazardous if engaged in a live socket outlet.

## ■ Special Instructions for U.K. Model

### IMPORTANT

THE WIRES IN MAINS LEAD ARE COLOURED IN ACCORDANCE WITH THE FOLLOWING CODE:

Blue: NEUTRAL  
Brown: LIVE

As the colours of the wires in the mains lead of this apparatus may not correspond with the coloured markings identifying the terminals in your plug, proceed as follows:

The wire that is coloured BLUE must be connected to the terminal that is marked with the letter N or coloured BLACK. The wire that is coloured BROWN must be connected to the terminal that is marked with the letter L or coloured RED. Making sure that neither core is connected to the earth terminal of the three-pin plug.

### CAUTION

Danger of explosion if battery is incorrectly replaced. Replace only with the same or equivalent type.

## Features

### ● Home Theater Sound System

With the Yamaha TSS-15 Home Theater Sound System, you can enjoy 5.1-channel surround sound at home—just like being at the movies.

### ● Dolby Digital, Pro Logic II, DTS & AAC

With Dolby Digital and DTS, you can enjoy the surround sound of DVD movies. With Dolby Pro Logic II, you can enjoy 5.1-channel surround from legacy Dolby Surround sources and normal stereo sources. The general model also supports AAC (Advanced Audio Coding).

### ● Cinema DSP

Yamaha's Cinema DSP technology offers Movie, Music, Sports, and Game listening modes for an enhanced listening experience.

### ● Silent Cinema

With Yamaha's Silent Cinema technology, you can enjoy multichannel surround sound even when using headphones.

### ● Virtual Surround

With the Virtual Surround function, you can enjoy 5.1-channel surround sound even when not using the surround left and right speakers. The surround speakers can then be used with the front speakers to provide extra power.

### ● Active Servo Technology



The subwoofer uses Yamaha's Active Servo technology to deliver incredible bass from its compact cabinet.

### ● QD-Bass Technology



The subwoofer employs Yamaha's QD-Bass (Quatre Dispersion Bass) technology, which uses a down-firing driver with a square, pyramid-shaped reflective plate to radiate the sound in four horizontal directions, providing extraordinary power and performance.



Manufactured under license from Dolby Laboratories. "Dolby", "Pro Logic", and the double-D symbol are trademarks of Dolby Laboratories.



"DTS" and "DTS Digital Surround" are registered trademarks of Digital Theater Systems, Inc.



Silent Cinema is a registered trademark of Yamaha Corporation.

## Contents

Features .....	1
Contents .....	1
Package Contents .....	2
Preparing the Remote Control .....	2
Fitting the Stand.....	2
Getting to Know the TSS-15 .....	3
Installing the Speakers.....	6
Hooking Up the System .....	8
Connecting the Speakers.....	9
Connecting Your Other Components.....	10
Connecting the Power Cable.....	11
Basic Operation .....	12
Adjusting Speaker Levels with the Test Tone ...	13
Using the Cinema DSP Listening Modes .....	14
Other Listening Modes .....	15
Troubleshooting .....	17
Glossary .....	19
Specifications .....	20



The "AAC" logo is a trademark of Dolby Laboratories. These are AAC patent numbers.

08/937,950	5,633,981	5,227,788	5,299,239
5848391	5 297 236	5,285,498	5,299,240
5,291,557	4,914,701	5,481,614	5,197,087
5,451,954	5,235,671	5,592,584	5,490,170
5 400 433	07/640,550	5,781,888	5,264,846
5,222,189	5,579,430	08/039,478	5,268,685
5,357,594	08/678,666	08/211,547	5,375,189
5 752 225	98/03037	5,703,999	5,581,654
5,394,473	97/02875	08/557,046	05-183,988
5,583,962	97/02874	08/894,844	5,548,574
5,274,740	98/03036	5,299,238	08/506,729

# Package Contents

Make sure that you have all the items shown here.

**TSS-15 amplifier**

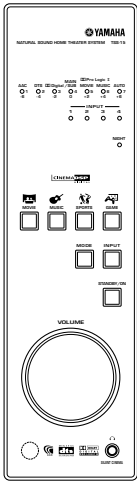

**Subwoofer**

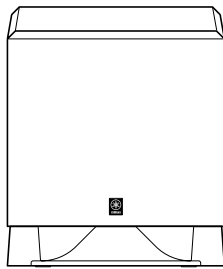

**Satellite speakers**

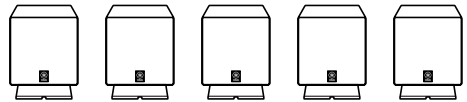

(Front L/R and center speakers have 3 meter cords, surround L/R speakers have 10 meter cords.)

**AC adaptor**  
(LSE9802B1540)

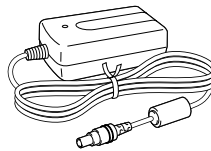

**Power cable**

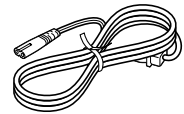

**Remote control**

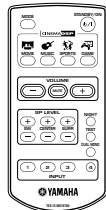

**Optical cable**



**Audio pin cable**

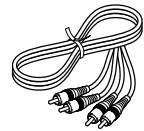

**Stand**

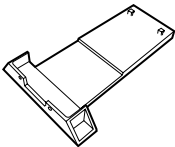

**Screws**



**Fastener**

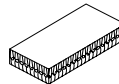

**Non-skid pads**

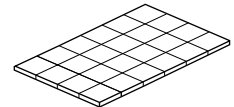

## Preparing the Remote Control

The remote control comes with the battery already installed. Before using the remote control for the very first time, pull out the plastic tab, as shown.

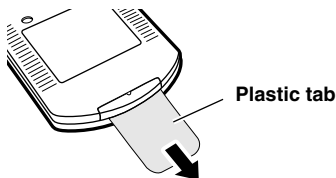

For information on replacing the battery, see page 18.

## Fitting the Stand

Before using the TSS-15 amplifier for the very first time, you must fit the stand for stability. Do not use the amplifier horizontally. Put the stand onto the base of the amplifier, and with a Phillips screwdriver, screw it to the amplifier with the two screws provided, as shown.

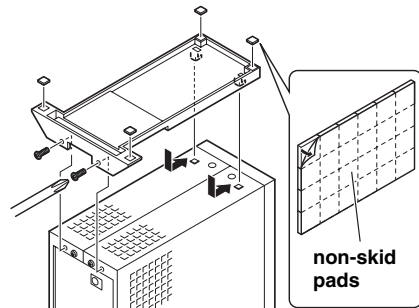

Affix four non-skid pads onto the base of the stand to prevent it from slipping.

# Getting to Know the TSS-15

## ■ Front Panel

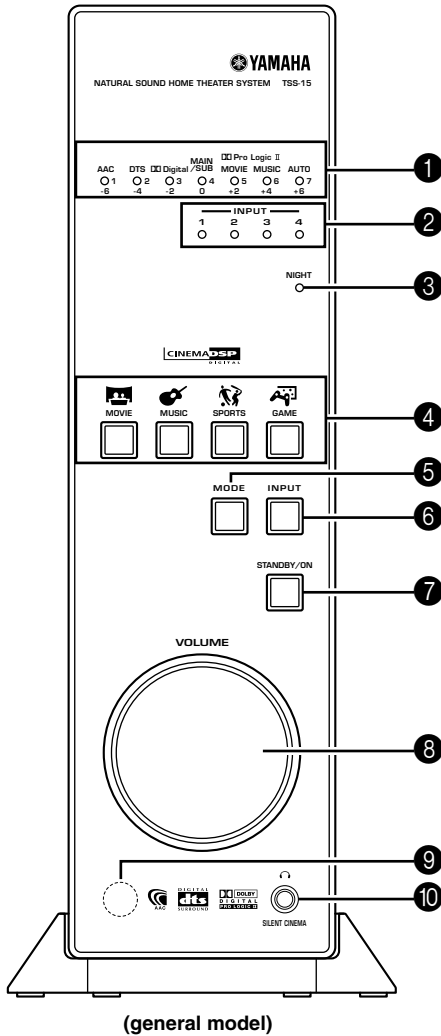

(general model)

### 1 Status, volume & level indicators

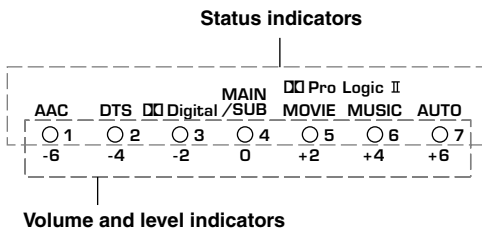

These are multipurpose indicators. Normally, they work as status indicators, indicating input signal format (Dolby Digital, DTS, etc) or Pro Logic II listening mode. When the VOLUME control is adjusted, they indicate the volume level setting from 1 through 7. After several seconds, they revert to status indicators,

and work as explained below. They're also used when adjusting individual speaker levels with the test tone (-6, -4, -2, 0, +2, +4, +6).

- **AAC indicator (general model only)**  
This indicator lights up when an AAC signal is input.
- **DTS indicator**  
This indicator lights up when a DTS signal is input.
- **Dolby Digital indicator**  
This indicator lights up when a Dolby Digital signal is input.
- **MAIN/SUB indicator**  
When listening to a multilingual TV program, this indicator lights up green when the main language is selected, and lights up red when the sub-language is selected. Main and sub are selected by using the remote control's [DUAL MONO] button.
- **MOVIE indicator**  
This indicator lights up when the Dolby Pro Logic II Movie listening mode is selected.
- **MUSIC indicator**  
This indicator lights up when the Dolby Pro Logic II Music listening mode is selected.
- **AUTO indicator**  
This indicator lights up when the Auto listening mode is selected.

### 2 INPUT 1-4 indicators

These indicators show which input is currently selected.

### 3 NIGHT indicator

This indicator lights up when the Night listening mode is selected (see page 15).

### 4 MOVIE, MUSIC, SPORTS & GAME buttons

These buttons are used to select the Movie, Music, Sports, and Game Cinema DSP listening modes. The button for the selected mode lights up (see page 14).

### 5 MODE button

This button is used to select the following listening modes: Dolby Pro Logic II Movie, Dolby Pro Logic II Music, or Auto (see page 15). It can also be used to cancel the Cinema DSP listening modes.

### 6 INPUT button

This button is used to select inputs 1 through 4 (see page 12).

### 7 STANDBY/ON button

This button is used to set the TSS-15 to On or Standby (see page 12).

#### Note:

While on Standby, the TSS-15 consumes a small amount of power so that it's able to receive commands from the remote control.

## 8 VOLUME control

This control is used to adjust the volume.

## 9 Remote control sensor

This sensor receives infrared signals from remote control.

## 10 SILENT CINEMA headphones jack

A pair of headphones can be connected to this mini jack for private listening. With Yamaha's Silent Cinema technology, you can enjoy multichannel surround sound even when using headphones. No sound is output by the speakers while a plug is inserted in this jack.

## Remote Control

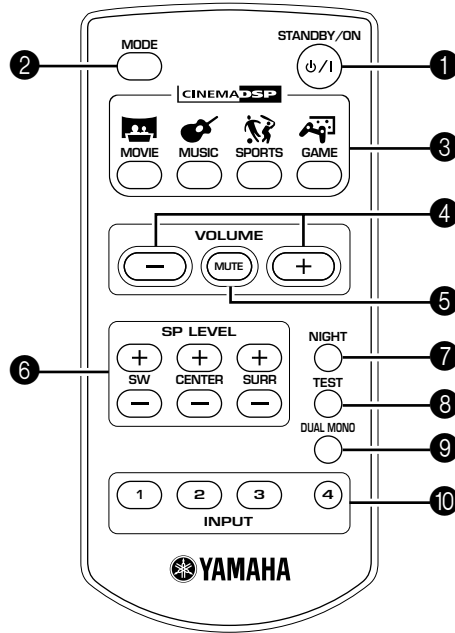

## 1 STANDBY/ON [⏻/|] button

This button is used to set the TSS-15 to On or Standby.

### Note:

While on Standby, the TSS-15 consumes a small amount of power so that it's able to receive commands from the remote control.

## 2 MODE button

This button is used to select the following listening modes: Dolby Pro Logic II Movie, Dolby Pro Logic II Music, or Auto (see page 15). It can also be used to cancel the Cinema DSP listening modes.

## 3 MOVIE, MUSIC, SPORTS & GAME buttons

These buttons are used to select the Movie, Music, Sports, and Game Cinema DSP listening modes. The button for the selected mode lights up (see page 14).

## 4 VOLUME [-] & [+] buttons

These buttons are used to adjust the volume. The Down [-] button reduces the volume, the Up [+] button increases it.

## 5 MUTE button

This button is used to mute the TSS-15. While the TSS-15 is muted, the volume level indicators flash. Press is again to unmute the TSS-15.

## 6 SP LEVEL buttons

These buttons are used to adjust the levels of the subwoofer (SW), center speaker (CENTER), and surround speakers (SURR) (see page 12).

## 7 NIGHT button

This button is used to set the Night listening mode (see page 15).

## 8 TEST button

This button is used to turn the test tone on or off (see page 13).

## 9 DUAL MONO button

When listening to a multilingual TV program, this button can be used to select the main, sub, or both languages.

## 10 INPUT buttons 1-4

These buttons are used to select inputs 1 through 4 (see page 12).

## ■ Using the Remote Control

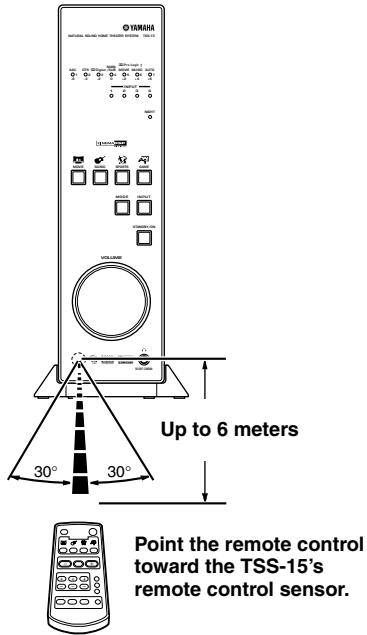

### Remote Control Precautions

- Do not spill water or other liquids on the remote control.
- Do not drop the remote control.
- Do not subject the remote control to the following:
  - high humidity, such as near a shower or bath
  - high temperatures, such as near a heater or stove
  - extremely low temperatures
  - dusty environments

# Installing the Speakers

Before you connect the speakers to the TSS-15 amplifier, you need to decide where to install them. To get the best results from the TSS-15, use all five satellite speakers and the subwoofer.

The three satellite speakers with 3-meter cords are the front left, front right, and center speakers. The two satellite speakers with 10-meter cords are the surround left and surround right speakers.

The following illustration shows the ideal position for each speaker relative to the TV and listening position.

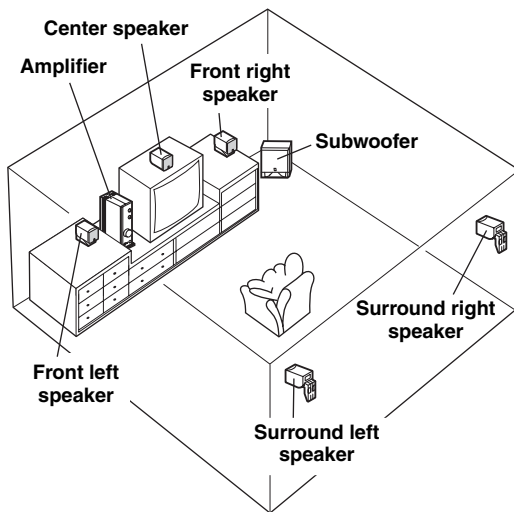

## ■ Front Speakers

The front speakers output the main sound. Place them either side of your TV, an equal distance from the listening position.

## ■ Center Speaker

With movies, the center speaker is used mainly for dialog. Position it centrally between the front speakers, preferably on top of your TV.

## ■ Surround Speakers

The surround left and right speakers output surround effects and ambience. They should be positioned behind the listening position, equidistant from the listener.

## ■ Subwoofer

The subwoofer outputs the bass sounds of the LFE (Low-Frequency Effects) channel. Since bass sounds are non-directional, the position of the subwoofer is not as important as for the other speakers. In general, a good bass sound can be achieved by putting the subwoofer in a corner at the front of the room. To prevent sound reflections from nearby walls, turn it inward so that it faces the listening position.

### **Note:**

The TSS-15 amplifier is designed to be used vertically. If it's used horizontally, heat may build up inside the case, causing damage or malfunction.

## ■ Preparing the Satellite Speakers

To prevent the satellite speakers from slipping, or vibrating when mounting on the wall, affix four non-skid pads to the base of each speaker stand, as shown.

To adjust the angle of a speaker, using a Phillips screwdriver, loosen the screw at the back of the stand, adjust the angle, and then tighten the screw.

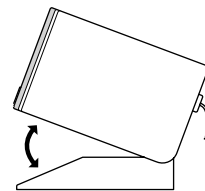
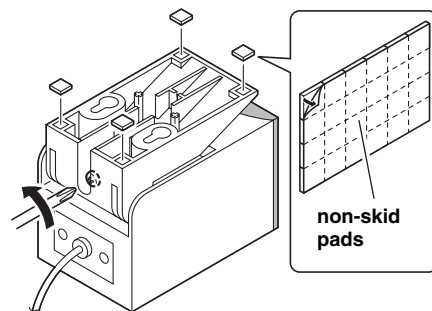

### **Note:**

Do not put the speakers on uneven surfaces.

## ■ Wall-Mounting the Satellite Speakers

The satellite speakers can be wall-mounted by using two #8 wood screws (sold separately).

**1** Using a Phillips screwdriver, loosen the screw at the back of the speaker stand, set the angle of the speaker as you want it, and then tighten the screw.

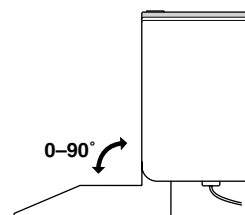



- 2** Position the speaker on the wall where you want to hang it, and use a pencil to mark the two hole positions.

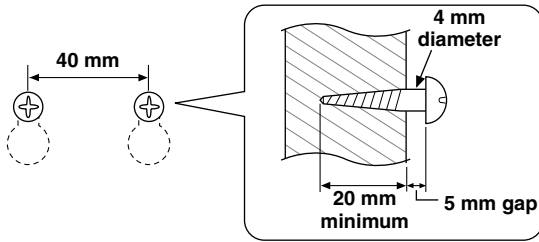

- 3** Screw two #8 screws into the wall, leaving a 5 mm gap to accept the keyhole slots.

- 4** Thread the speaker cord around the strain-relief guide and out through the slot at the front of the speaker stand, as shown.

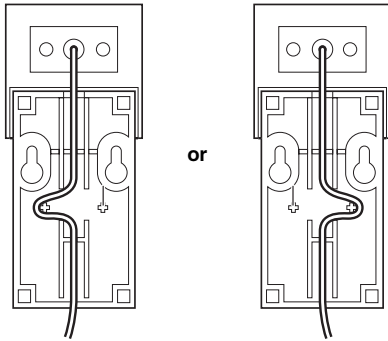

- 5** Fit the speaker stand onto the screws and push it down so that the screw heads sit correctly in the keyhole slots.

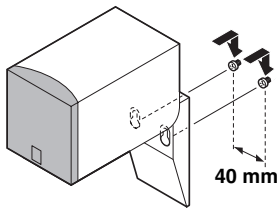

**Cautions:**

- Each satellite speaker weighs 0.4 kg. Heed the following cautions to ensure that the speakers do not fall and cause damage or injury.
- Once the satellite speakers have been mounted on the wall, check each speaker to ensure that there's no possibility of it falling. Yamaha cannot be held responsible for any damage or injury caused by falling speakers.
- If you have hollow walls, make sure that the screws go into the studs. If there are no studs, or the walls are solid, use suitable wall anchors.
- Use 1-inch #8 screws (4 mm shank diameter) with a head diameter of 8 mm or less.

- Do not use nails or double-sided tape to mount the speakers.
- Use cord clips to secure the speaker cords to the wall.

**■ Securing the Center Speaker to Your TV**

To prevent the center speaker from slipping, you can secure it to your TV by using the fastener provided. You must remove its stand first.

**Notes:**

- Do not put the center speaker on top of your TV if it overhangs (i.e., the top of the TV is not deep enough).
- Do not put the center speaker on top of your TV if the top is not level.
- Do not touch the adhesive side of the fastener after peeling off the backing.
- Wipe the top of your TV before attaching the fastener.

- 1** To remove the center speaker's stand, using a Phillips screwdriver, remove the screw and washer at the back of the stand.

Keep the screw and washer for future use.

- 2** Peel the backing off one side of the fastener, and affix it to the top of your TV.

- 3** Peel the backing off the other side of the fastener, and affix the center speaker on top.

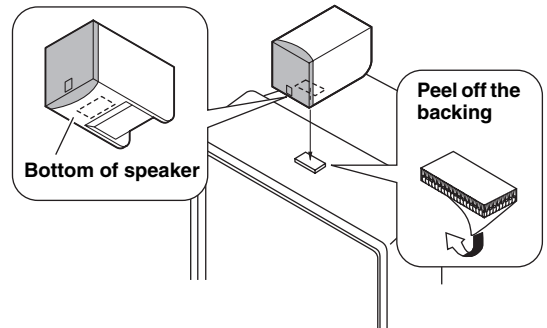

**Note:**

Although the speakers are magnetically shielded to prevent interference, if the TV picture is distorted, try moving the speakers away from your TV.

# Hooking Up the System

You can connect up to four audio components to the TSS-15. This could be a DVD player, CD player, games console, TV, VCR, DVR (digital video recorder), set-top box (digital satellite, cable, over the air), camcorder, and so on. The following diagram shows a typical setup.

## Caution:

Before making any connections, disconnect each component's power cable from the wall outlet.

## Notes:

- Connect the white plug of the audio cable to the left "L" (white) jack. Connect the red plug to the right "R" (red) jack.
- Push each plug firmly into its jack. Loose connections can cause noise or malfunction.
- Before connecting your other components to the TSS-15, refer to their instruction manuals.
- Do not connect video signals to any of the TSS-15's jacks. The TSS-15 only supports audio signals.

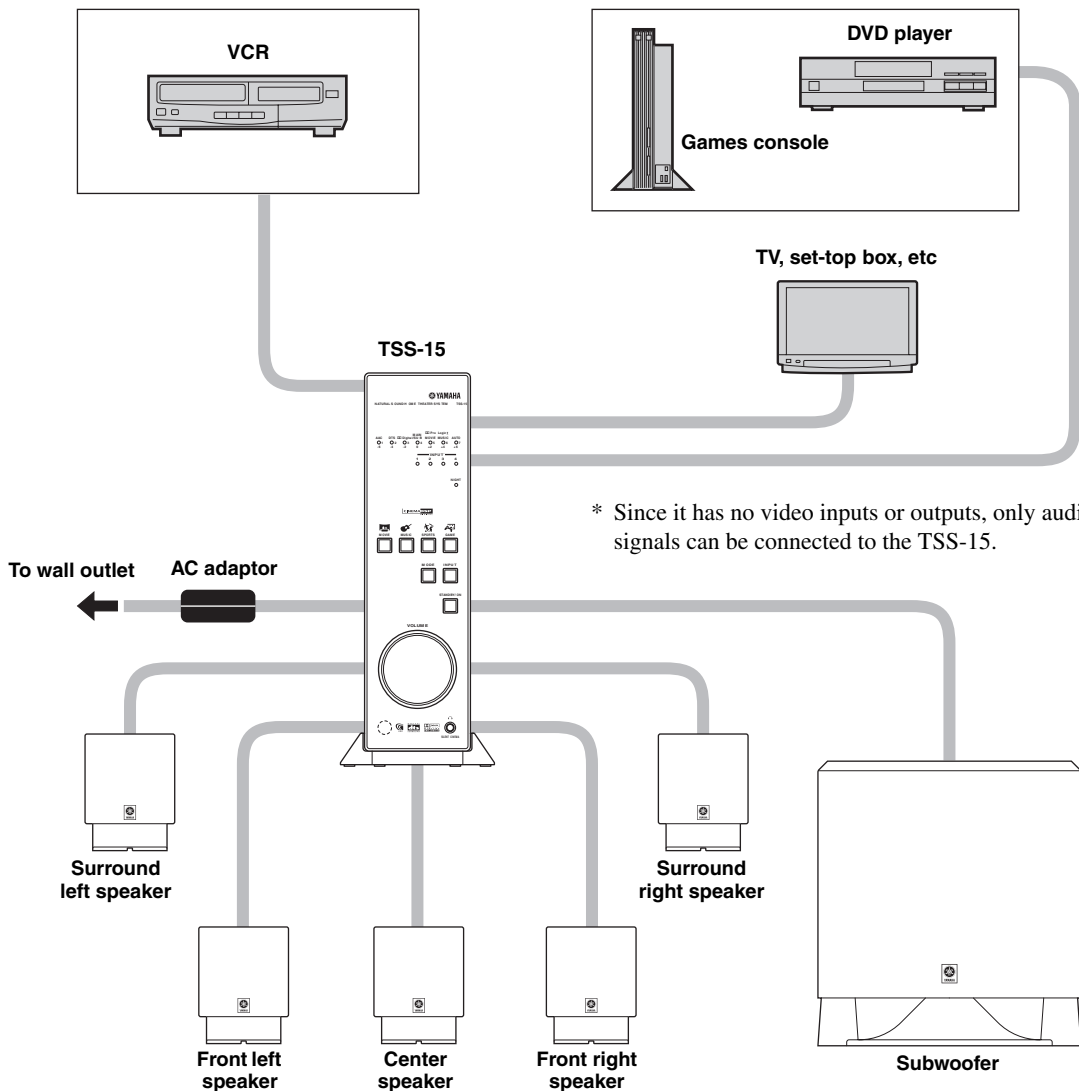

## Connecting the Speakers

The diagram below shows how to connect the speakers to the TSS-15.

The three satellite speakers with 3-meter cords are the front left, front right, and center speakers. The two satellite speakers with 10-meter cords are the surround left and surround right speakers.

### Cautions:

- Connect only the included speakers to the TSS-15. Speakers from other manufacturers are not designed to work with the TSS-15 and may use different connectors.
- Never connect the speaker outputs to another amplifier, as this may cause a malfunction, seriously damage the TSS-15 or amplifier, or cause a fire.
- To prevent people from tripping over or damaging the speaker cables, tidy and secure them once they're connected.

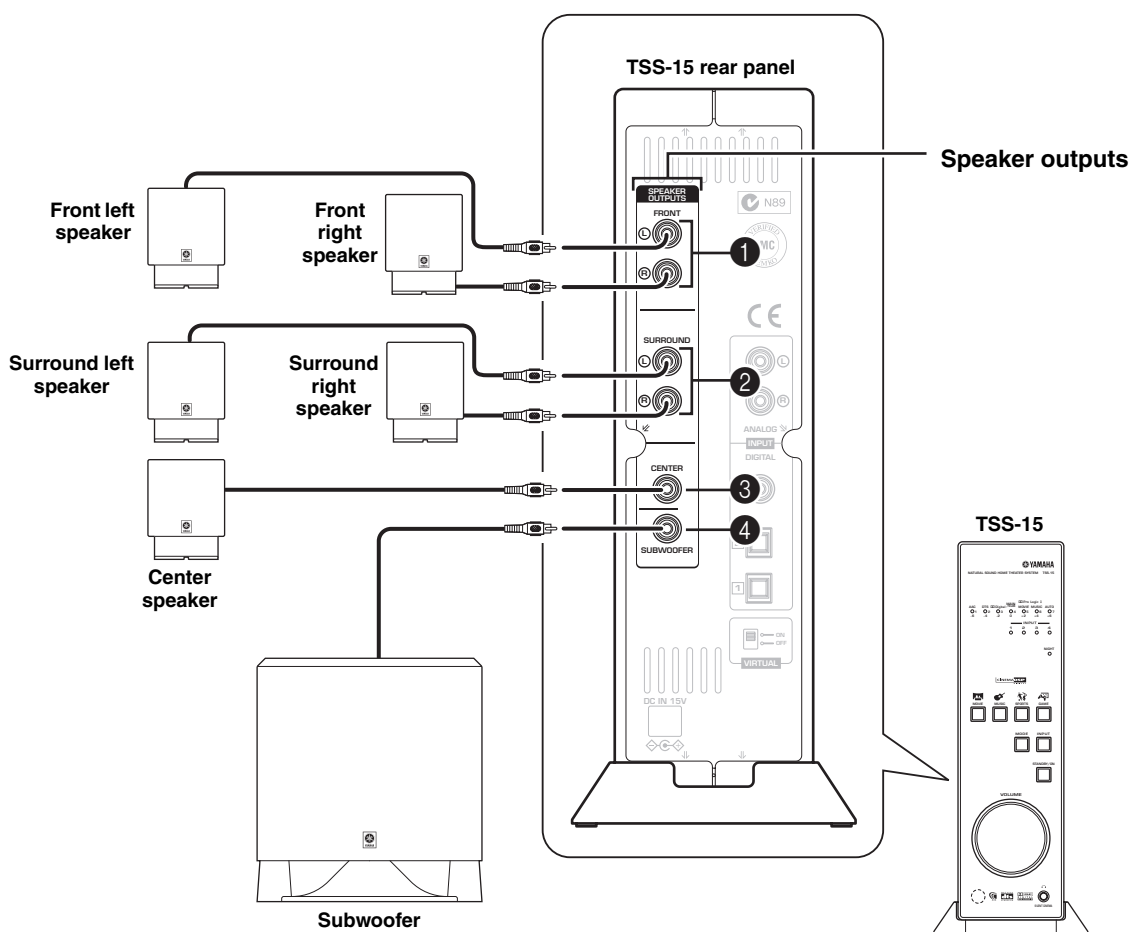

### ■ Speaker Outputs

#### ① FRONT L/R

Connect the front left and right speakers.

#### ② SURROUND L/R

Connect the surround left and right speakers.

#### ③ CENTER

Connect the center speaker.

#### ④ SUBWOOFER

Connect the subwoofer.

## Connecting Your Other Components

The following diagram shows how to connect your components to the TSS-15.

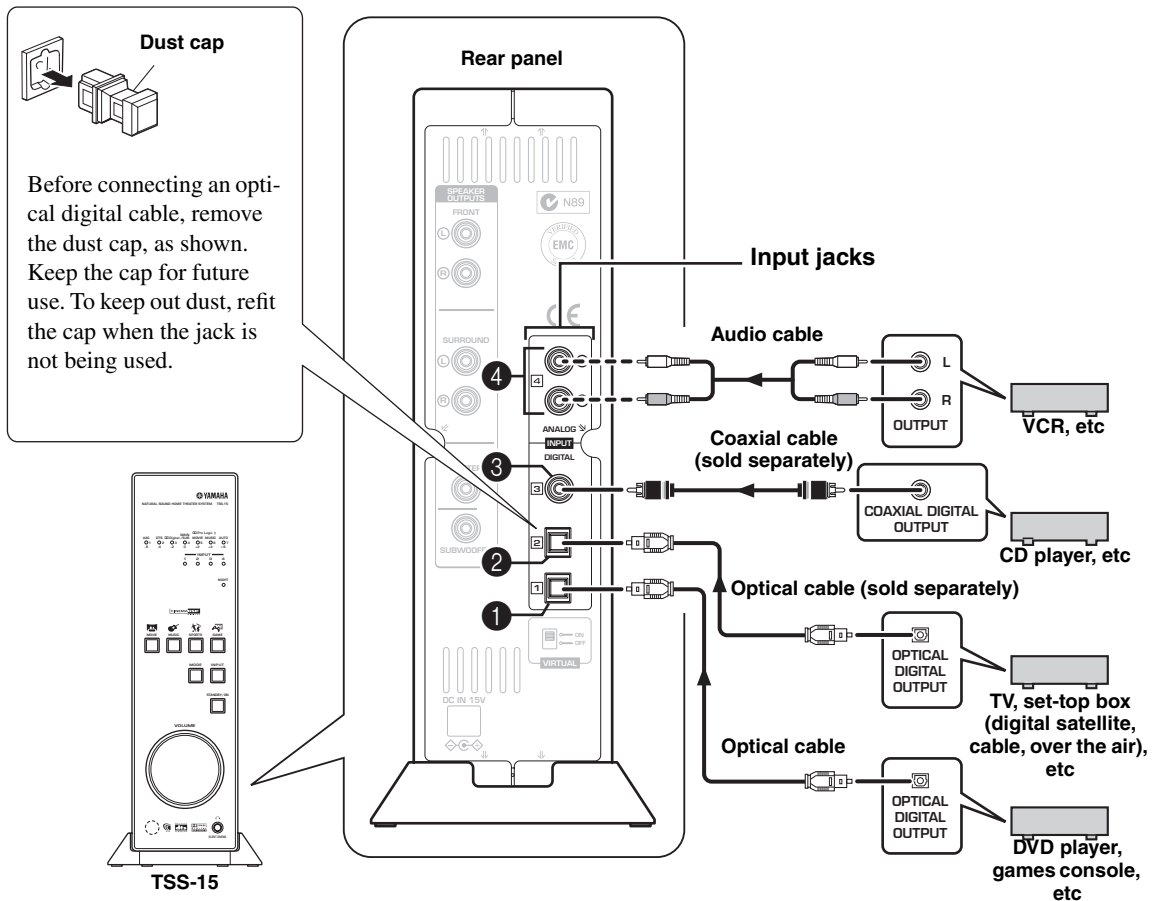

### ■ Audio Inputs

The TSS-15 has four YAMAHA inputs. Inputs 1, 2, and 3 accept digital audio signals. Input 4 accepts analog audio signals.

#### 1 DIGITAL INPUT 1

Use the supplied optical digital audio cable to connect the digital audio output of a DVD player, etc., to this optical digital input.

#### 2 DIGITAL INPUT 2

Use an optical digital audio cable (sold separately) to connect the digital audio output of a TV, etc., to this optical digital input.

#### 3 DIGITAL INPUT 3

Use a coaxial digital audio cable (sold separately) to connect the digital audio output of a CD player, etc., to this optical digital input.

#### 4 ANALOG INPUT 4

Use the audio cable to connect the analog audio output of a VCR, etc., to this analog input.

### Notes:

- You can connect your computer to ANALOG INPUT 4 by using a mini plug to RCA conversion cable, or an adaptor.
- Since the TSS-15 doesn't have any video inputs and outputs, connect the video output from your DVD player or VCR directly to your TV.

## Connecting the Power Cable

Do not connect the power cable until you have completed and double-checked all audio connections.

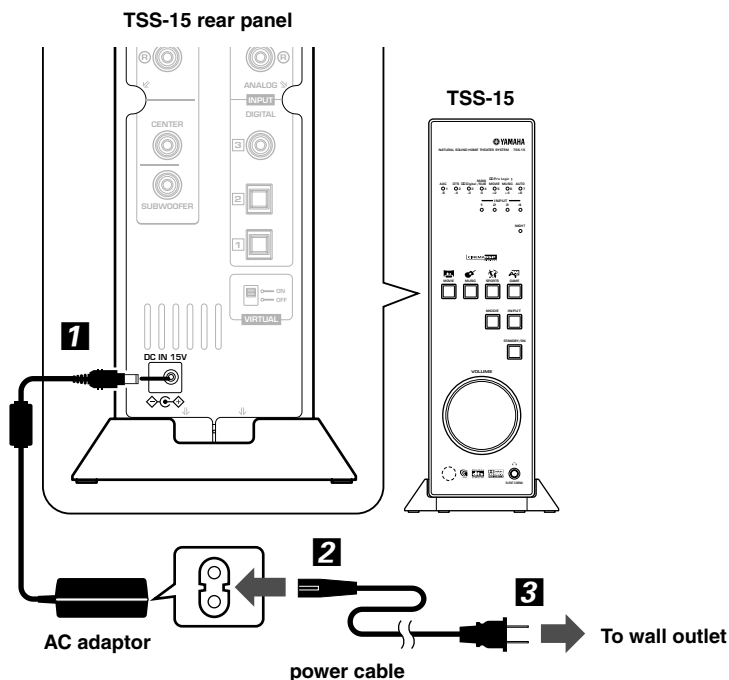

**1** Connect the AC adaptor to the DC IN 15V jack on the TSS-15's rear panel.

**2** Connect the power cable to the AC adaptor.

**3** Plug the power cable into a suitable wall outlet.

### Cautions:

- Unplug the power cable from the wall outlet if you plan not to use the TSS-15 for an extended period.
- If you put the AC adaptor on a shelf or rack, position it so that it's unlikely to fall, as it may cause injury or damage to another component or itself.
- Use only the included AC adaptor with the TSS-15 amplifier. Using another adaptor may cause a malfunction or fire.
- Do not use the AC adaptor with any device other than the TSS-15.

# Basic Operation

This section explains the basic operation.

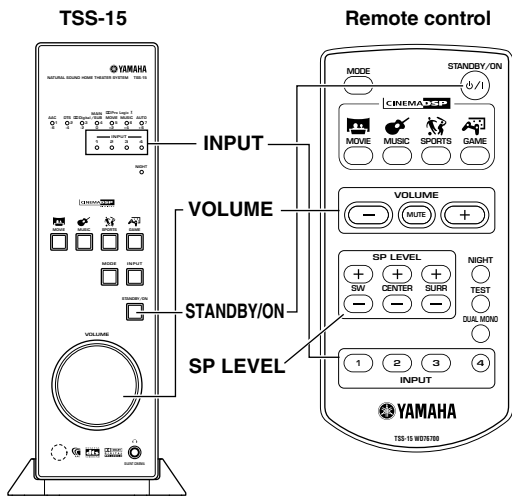

## ■ Listening to a Sound Source

**1** To turn on the TSS-15, press the [STANDBY/ON] button.

The STANDBY/ON button on the TSS-15 lights up.

**2** Turn on the source component.

**3** Use the remote control's INPUT buttons, or the TSS-15's [INPUT] button to select the input to which the component is connected.

The INPUT indicator for the selected input lights up.

**4** Start playback on the component.

See the component's instruction manual for details.

**5** Use the remote control's VOLUME Up [+] and Down [-] buttons, or the TSS-15's VOLUME control to adjust the volume.

While it's being adjusted, the volume level is shown by the TSS-15's volume indicators for several seconds.

## ■ Adjusting the Level of the Subwoofer, Center, or Surround Speakers

While listening to a sound source, use the SP LEVEL Up [+] and Down [-] buttons to adjust the level of the subwoofer (SW), center speaker (CENTER), or surround speakers (SURR).

### Notes:

- The TSS-15 supports Dolby Digital, DTS, and AAC (general model only) digital audio with a sampling rate of 48 kHz or less, and PCM audio up to 96 kHz.
- The Cinema DSP and Dolby Pro Logic II listening modes cannot be used with 96 kHz PCM audio.
- The subwoofer, center, and surround speaker levels cannot be adjusted while a pair of headphones is connected.

## ■ Muting the TSS-15

To temporarily mute the TSS-15, press the remote control's [MUTE] button. The volume level indicators flash on the TSS-15. To unmute the TSS-15, press the [MUTE] button again. If you adjust the volume while the TSS-15 is muted, or press any other button, it will be unmuted automatically.

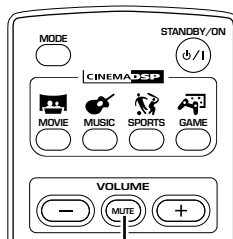

Press the [MUTE] button to mute the TSS-15

## ■ Turning Off the TSS-15

To turn off the TSS-15, press the [STANDBY/ON] button on the remote control or TSS-15 to set it to Standby.

While on Standby, the TSS-15 consumes a small amount of power so that it's able to receive commands from the remote control.

### Note:

The next time you turn on the TSS-15, the previously selected input (1-4) and listening mode will be selected automatically.

## Adjusting Speaker Levels with the Test Tone

It's important that all speakers can be heard equally at the listening position. The TSS-15 has a built-in test tone for adjusting the level of each speaker.

### Notes:

- The test tone cannot be used while a pair of headphones is connected.
- The Night listening mode cannot be used while the test tone is being output.
- The test tone can be used with the Virtual Surround function (see page 16).

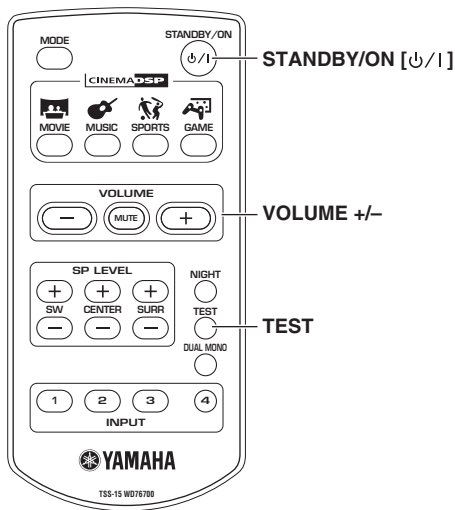

This procedure should be performed from the listening position.

### 1 To turn on the TSS-15, press the [STANDBY/ON] button.

The STANDBY/ON button on the TSS-15 lights up.

### 2 Set the volume to about 4.

### 3 Press the [TEST] button.

The test tone is output by each speaker for 2.5 seconds in the following order: front left, center, front right, surround right, surround left, subwoofer.

The TSS-15's CINEMA DSP buttons indicate which speaker is currently outputting the test tone, as shown below.

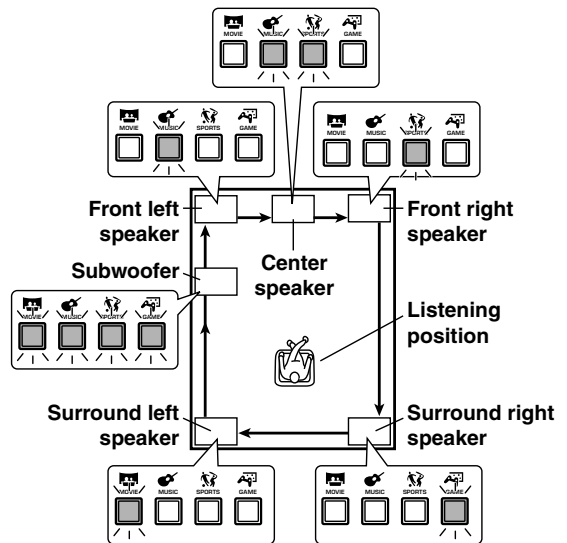

### Note:

If the test tone is too quiet, turn up the TSS-15 amplifier's VOLUME control. If it's too loud, turn it down.

### 4 While the test tone is being output by a speaker, use the VOLUME Up [+] and Down [-] buttons to adjust its level.

While the level is being adjusted, the test tone will continue to be output by the same speaker. When you stop adjusting the level, the test tone will be output by the next speaker in the order stated above.

### Notes:

- The level of each speaker is shown by the volume level indicators on the TSS-15 (-6, -4, -2, 0, +2, +4, +6).
- The front left and right speaker levels cannot be set above 0.
- To reset all speakers to their default levels, while the test tone is being output, press the TSS-15 amplifier's [MODE] button for two seconds.

### 5 When you've finished adjusting the level of each speaker, press the [TEST] button again to turn off the test tone.

# Using the Cinema DSP Listening Modes

Yamaha's Cinema DSP technology offers Movie, Music, Sports, and Game listening modes for an enhanced listening experience. In addition, you can use all five speakers even with stereo music sources, including CDs, videos, games, and so on.

To select the Cinema DSP listening modes, use the [MOVIE], [MUSIC], [SPORTS], and [GAME] buttons. The corresponding button lights up. To turn the mode off, press the button again, or press the [MODE] button.

## Notes:

- The Cinema DSP listening modes cannot be used with mono or multilingual (main/sub) audio sources.
- The TSS-15 remembers which listening mode you previously used with each input so the next time you select an input, the listening mode is selected automatically.
- Feel free to choose a listening mode based on your listening preference, and not purely on the name of the mode itself.

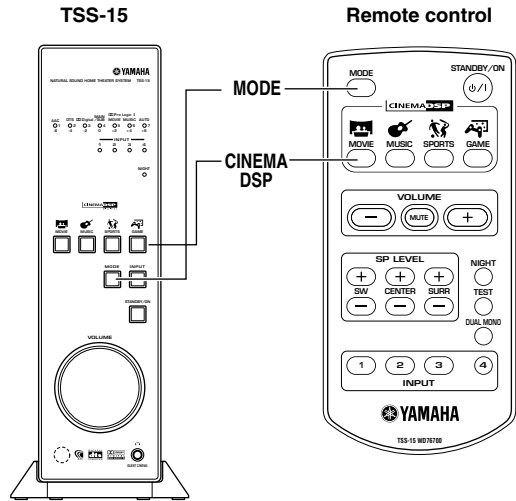

## About the Cinema DSP Listening Modes

Listening mode	Description
<b>Movie</b>	With this mode, you can enjoy a movie theater-like experience in your own home theater. The TSS-15's [MOVIE] button lights up when this mode is selected.
<b>Music</b>	With this mode you can experience the excitement of a live concert hall. The TSS-15's [MUSIC] button lights up when this mode is selected.
<b>Sports</b>	With this mode, you can enjoy watching sports surrounded by the sounds of the crowd, the stadium, and the game. The TSS-15's [SPORTS] button lights up when this mode is selected.
<b>Game</b>	With this mode, you can enjoy the dynamics and thrills of three-dimensional surround sound effects. The TSS-15's [GAME] button lights up when this mode is selected.

## Notes:

- The Cinema DSP listening modes can be used with Dolby Digital, DTS, AAC (general model only), PCM, or analog audio sources.
- When used with a Dolby Digital, DTS, or AAC (general model only) source, the DIGITAL, DTS, or AAC indicator lights up.
- When used with a stereo (2-channel) source, Dolby Pro Logic II Movie mode is used to create 5.1-channels, and the MOVIE indicator lights up.



## Other Listening Modes

### ■ Using Dolby Pro Logic II

With Dolby Pro Logic II, you can enjoy 5.1-channel surround from legacy Dolby Surround sources (video, laser disc, etc) or normal stereo sources (CDs, etc). There are two modes: Movie mode for watching movies, and Music mode for listening to music.

To select Dolby Pro Logic II, use the [MODE] button to select Movie mode or Music mode. The  Pro Logic II MOVIE or MUSIC indicator lights up.

### ■ Listening with No Processing

With Auto mode, you can listen to music and other sources with no Cinema DSP processing. Analog and PCM sources will be heard through the front left and right speakers and subwoofer. Dolby Digital, DTS, and AAC (general model only) will be decoded and output by the appropriate speakers.

To select Auto mode, press the [MODE] button repeatedly until the AUTO indicator lights up.

### ■ Night Listening Mode

In Night Listening mode, the audio dynamic range is reduced so that you can hear quiet dialog even when listening at low volume levels—useful when you don't want to disturb anyone else.

#### **Note:**

The Cinema DSP listening modes can be used with Night listening mode.

#### **1** To select Night listening mode, press the [NIGHT] button.

The NIGHT indicator lights up.

#### **2** To cancel Night listening mode, press the [NIGHT] button again.

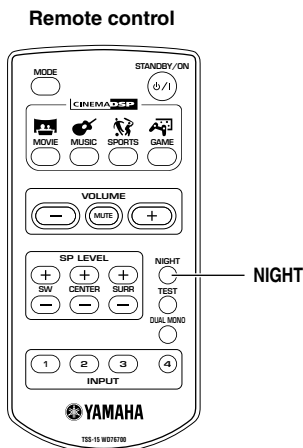

### ■ Using Headphones & Silent Cinema

With the Silent Cinema function, you can enjoy multichannel surround sound, including Dolby Digital and DTS, even when using headphones.

To use Silent Cinema, simply connect your headphones to the  SILENT CINEMA headphones jack.

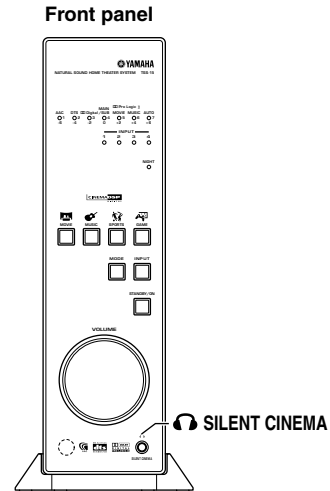

#### **Notes:**

- No sound is output by the speakers while a plug is inserted in the  SILENT CINEMA headphones jack.
- Silent Cinema can be used with the Cinema DSP listening modes.
- To listen to stereo (2-channel) sources (CDs, etc) without Silent Cinema, turn off the Cinema DSP listening modes, and use the [MODE] button to select Auto mode.

## ■ Virtual Surround

With the Virtual Surround function, you can enjoy 5.1-channel surround sound even when the surround left and right speakers are not used. The surround speakers can then be used as front speakers to provide extra power.

To turn on the Virtual Surround function, set the TSS-15 to Standby, and then set the VIRTUAL switch on the rear panel to ON.

### **Note:**

The Virtual Surround function can be turned on or off only when the TSS-15 is on Standby. Setting the VIRTUAL switch while the TSS-15 is on will have no effect.

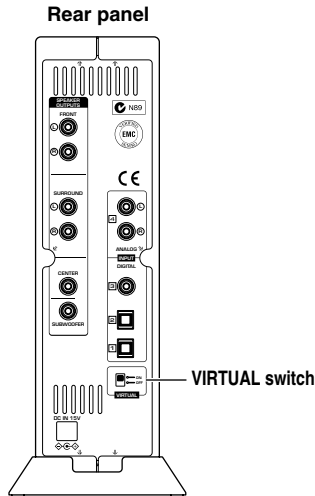

## ■ Boosting the Front Speaker Volume

In Virtual Surround mode, the surround left and right speakers can be used in addition to the front left and right speakers to provide extra power. In this mode, the front left and surround left speakers output the same sound. Likewise, the front right and surround right speakers output the same sound.

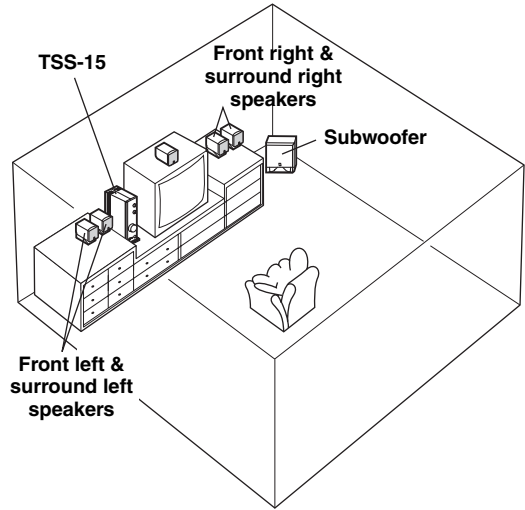

When using the surround speakers as front speakers, you can adjust their positions to optimize the sound dispersion.

### **Note:**

The test tone can be used with the Virtual Surround function to adjust the level of each speaker (see page 13). The level of the surround speakers cannot be adjusted independently of the front speakers.

## ■ Energy Saving Function

The TSS-15 has an energy saving function. If it's left on and no controls are operated for 24 hours, it will automatically switch to Standby mode.

# Troubleshooting

If the TSS-15 Home Theater Sound System does not work properly, refer to the table below. If the problem is not listed, or if the suggested remedy fails to resolve the problem, set the TSS-15 to Standby, disconnect the power cable from the wall outlet, and contact your Yamaha dealer.

Problem	Possible cause	Remedy	Refer to page
<b>The TSS-15 turns itself off as soon as it's turned on.</b>	The power cable is not connected properly.	Make sure that the power cable is properly connected to a suitable wall outlet.	11
	A speaker cord has a short circuit so the amplifier protection system has turned the TSS-15 off automatically.	Make sure that all speaker cords are properly connected and check for any shorts.	9
	The TSS-15 amplifier was exposed to a strong external electrical shock, such as lightning or excessive static electricity.	Set the TSS-15 to Standby, and then disconnect the power cable from the wall outlet. Wait about 30 seconds, plug the power cable in again, and then turn on the TSS-15.	—
	The TSS-15 has been used at high volume levels and the amplifier protection system has turned the TSS-15 off automatically.	Use the TSS-15 at a lower volume.	12
	The TSS-15 amplifier is excessively hot and the protection system has turned it off automatically.	Wait a few minutes for the amplifier to cool down.	—
<b>No sound can be heard.</b>	Connections are incomplete.	Make sure that the speakers and other components are properly connected.	9–10
	The wrong input is selected.	Select the appropriate input. If the DTS indicator is flashing, select another input, then select the previous input.	12
	The volume is set too low.	Turn up the volume.	12
	The TSS-15 has been muted.	Press the [MUTE] button to unmute the TSS-15.	12
<b>One speaker outputs no sound.</b>	The speaker is not connected properly.	Check the speaker connections.	9
<b>Only the front speakers output sound.</b>	The Auto listening mode is selected and the audio source is stereo.	To use all speakers, select a Cinema DSP or Dolby Pro Logic II listening mode.	14–15
	The Dolby Surround, Dolby Digital, or DTS source does not include surround channel information.		
	Digital audio signals with a sampling rate above 48 kHz are output by only the front speakers.	—	—
<b>The center speaker outputs no sound.</b>	The center speaker's volume level is set to minimum.	Use the remote control's SP LEVEL CENTER Up [+] button to increase the level.	12
	Some multichannel sources do not include center channel information.	—	—
<b>The surround speakers output no sound.</b>	The surround speakers' volume level is set to minimum.	Use the remote control's SP LEVEL SURR Up [+] button to increase the level.	12
<b>The subwoofer outputs no sound.</b>	The subwoofer's volume level is set to minimum.	Use the remote control's SP LEVEL SW Up [+] button to increase the level.	12
	Some source material does not include sub-bass sounds.	—	—

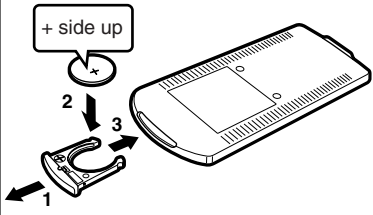
Problem	Possible cause	Remedy	Refer to page	
<b>The source is Dolby Digital and the Auto listening mode is selected, but the center and surround speakers output no sound.</b>	The Dolby Digital signal contains only two channels.	If the DVD being played has a 5.1-channel soundtrack, select it on the DVD player. If not, you can still use all speakers by selecting the Dolby Pro Logic II Movie or Music listening mode.	15	
<b>The source is Dolby Digital or DTS, but the Dolby Digital or DTS indicator doesn't light up.</b>	The DVD player is not set correctly.	Make sure that the DVD player is configured to output Dolby Digital and DTS (bitstream) signals from its digital output. Refer to its manual for details.	—	
<b>A humming noise can be heard.</b>	An audio cable is not connected properly.	Check all audio connections and correct as necessary.	10	
<b>Noise can be heard.</b>	The level of the input signal is too low.	Increase the output level on the source component.	—	
	An audio cable is not connected properly.	Check all audio connections and correct as necessary.	10	
<b>The sound is distorted.</b>	The level of the input signal is too high.	Reduce the output level on the source component.	—	
<b>The TSS-15 doesn't work properly.</b>	The internal microprocessor has locked up due to external electrical shock (lightning or excessive static electricity) or a drop in the power supply voltage.	Disconnect the power cable from the wall outlet, wait for about 30 seconds, then plug it back in again.	—	
<b>Noise can be heard when the TSS-15 amplifier is situated close to another electronic device.</b>	The electronic device's high-frequency circuits are causing interference on the TSS-15 amplifier.	Move the TSS-15 amplifier and electronic device away from each other.	—	
<b>The remote control doesn't work.</b>	The battery is depleted.	<p>Replace with a new CR2025 battery.</p> <ol style="list-style-type: none"> <li>Using a small screwdriver, carefully slide out the battery holder.</li> <li>Remove the expired battery, and place the new battery onto the battery holder with the + side facing up.</li> <li>Slide the battery holder into the remote control, and push it so that it clicks shut.</li> </ol>  <ul style="list-style-type: none"> <li>Do not attempt to recharge the old battery.</li> <li>Dispose of the old battery in accordance with local regulations.</li> </ul>	—	
	You're too far away from the TSS-15.	The remote control has a maximum working range of 6 meters (20 feet), and a working angle of 30 degrees.		5
	Direct sunlight or lighting (inverter-type fluorescent light, etc) is shining on the TSS-15's remote control sensor.	Reposition the TSS-15 amplifier.		—

# Glossary

## 5.1-channel

Refers to a six-channel surround sound format. The 5 refers to the five full-range audio channels (left, right, center, surround left, and surround right), and the .1 refers to the frequency-limited LFE (Low Frequency Effects) channel, which is used for sub-bass effects between 20 Hz and 120 Hz.

## AAC

AAC, which stands for Advanced Audio Coding, is a new audio encoding format that uses more efficient compression than the MP3 format, yet offers audio quality on par with that of CD. AAC was developed by the MPEG group and is used in the new MPEG-4 video format.

## Dolby Digital

This is the designated digital surround sound format for DVD-Video, HDTV, and select digital broadcasts (cable, satellite, over the air). A Dolby Digital bitstream may contain mono, stereo, Dolby Surround, or 5.1-channel audio information. Dolby Digital uses lossy compression to squeeze six channels of information into a single digital bitstream. Unlike Dolby Surround and Dolby Pro Logic that use matrix encoding, Dolby Digital uses discrete channels.

## Dolby Pro Logic

The matrix decoder used in home theater equipment to decode Dolby Surround material.

## Dolby Pro Logic II

The second generation Dolby Pro Logic matrix decoder can create quasi 5.1-channel surround (left, right, center, surround left, and surround right) from legacy Dolby Surround sources and normal stereo sources. It offers Movie and Music listening modes.

## Dolby Surround

The home version of the original Dolby Stereo surround system used in movie theaters. It uses matrix encoding to deliver four channels (left, right, center, and surround) of information via two audio channels. It's commonly used for video, laser disc, analog TV, and other stereo analog systems.

## DTS

Developed by Digital Theater Systems, DTS is a 5.1-channel digital surround format similar to Dolby Digital, except it uses less compression for a more faithful sound. It's commonly used with DVD-Video and DTS CDs.

## PCM

PCM signals are linear, noncompressed digital audio signals. Normal CDs contain 16-bit/44.1 kHz PCM. A DVD may contain 16-bit/48 kHz through 24-bit/96 kHz PCM.

## Silent Cinema

Yamaha's Silent Cinema technology allows you to enjoy multichannel surround sound even when using headphones.

## Yamaha Cinema DSP

Since Dolby Surround and DTS were originally developed for use in movie theaters, it's inevitable that sounds will not be heard exactly how the original sound designer intended when listened to in a typical home environment, with the smaller room size, wall construction, and number of speakers. Using a wealth of measured data, Yamaha's Cinema DSP technology uses Yamaha's own sound-field technology to combine Dolby Pro Logic, Dolby Digital, and DTS to supplement the scale, depth and volume of sounds, thereby recreating the audio experience of a movie theater in the home theater environment.

## Yamaha Virtual Surround

Yamaha's Virtual Surround technology allows you to enjoy 5.1-channel surround sound even when not using the surround left and right speakers. The surround speakers can then be used with the front speakers to provide extra power.

# Specifications

## • Amplifier unit

### Output Power per Channel

Front/center/surround: 6W x 5 (1 kHz, 4 Ω, 10 % THD)  
Subwoofer: 18W (100 Hz, 4 Ω, 10 % THD)

Input Sensitivity ..... 200 mV

### H. P. Output Level/Output Impedance

..... 450 mV/30 Ω (1 kHz, 200 mV)

Frequency Response ..... 40 Hz–20 kHz

### Dimensions (W x H x D)

..... 102 mm x 260 mm x 196 mm

Weight ..... 1.3 kg

Power Consumption ..... 40 W

### Standby Power Consumption

..... 0.8 W (100–120V), 1.1 W (220–240V)

## • Satellite speakers

Type ..... Full range speaker system acoustic suspension

Driver ..... 5 cm (2") cone type  
Magnetic shielding type

Impedance ..... 4 Ω

### Dimensions (W x H x D)

..... 70 mm x 91 mm x 110 mm (include stand)

Weight ..... 0.4 kg

\* Please note that all specifications are subject to change without notice.

## • Subwoofer

Type ..... Active Servo Processing Subwoofer System

Driver ..... 13 cm (5") cone woofer  
Magnetic shielding type

Impedance ..... 4 Ω

### Dimensions (W x H x D)

..... 220 mm x 239 mm x 220 mm

Weight ..... 3.4 kg

# Caracteristiques techniques

## • Unité d'amplification

### Puissance de sortie par canal

Avant/centrale/surround: 6W x 5 (1 kHz, 4 Ω, 10 % THD)

Caisson de graves: 18W (100 Hz, 4 Ω, 10 % THD)

Sensibilité d'entrée ..... 200 mV

### Niveau de sortie des enceintes/

#### Impédance de sortie de la prise casque

..... 450 mV/30 Ω (1 kHz, 200 mV)

Sensibilité d'entrée ..... 40 Hz–20 kHz

Dimensions (L x H x P) .... 102 mm x 260 mm x 196 mm

Poids ..... 1,3 kg

Consommation électrique ..... 40 W

#### Consommation en veille

..... 0,8 W (100–120V), 1,1 W (220–240V)

## • Caisson de graves

Type .... de système de subwoofer à traitement servo actif

#### Entraînement

..... 13 cm de type cône à woofer  
Blindage magnétique

Impédance ..... 4 Ω

#### Dimensions (L x H x P)

..... 220 mm x 239 mm x 220 mm

Poids ..... 3,4 kg

## • Enceintes satellites

Type ..... Enceinte à gamme intégrale  
Acoustic suspension

#### Entraînement

..... Type à cône de 5 cm  
Blindage magnétique

Impédance ..... 4 Ω

#### Dimensions (L x H x P)

..... 70 mm x 91 mm x 110 mm (y compris le pied)

Poids ..... 0,4 kg

\* Noter que toutes les caractéristiques techniques sont modifiables sans préavis.



© 2004 YAMAHA CORPORATION All rights reserved.

YAMAHA ELECTRONICS CORPORATION, USA 6660 ORANGETHORPE AVE., BUENA PARK, CALIF. 90620, U.S.A.  
YAMAHA CANADA MUSIC LTD. 135 MILNER AVE., SCARBOROUGH, ONTARIO M1S 3R1, CANADA  
YAMAHA ELECTRONIK EUROPA G.m.b.H. SIEMENSSTR. 22-34, 25462 RELLINGEN BEI HAMBURG, F.R. OF GERMANY  
YAMAHA ELECTRONIQUE FRANCE S.A. RUE AMBROISE CROIZAT BP70 CROISSY-BEAUBOURG 77312 MARNE-LA-VALLEE CEDEX02, FRANCE  
YAMAHA ELECTRONICS (UK) LTD. YAMAHA HOUSE, 200 RICKMANSWORTH ROAD WATFORD, HERTS WD18 7GQ, ENGLAND  
YAMAHA SCANDINAVIA A.B. J A WETTERGRENS GATA 1, BOX 30053, 400 43 VÄSTRA FRÖLUNDA, SWEDEN  
YAMAHA MUSIC AUSTRALIA PTY, LTD. 17-33 MARKET ST., SOUTH MELBOURNE, 3205 VIC., AUSTRALIA

YAMAHA CORPORATION  
Printed in China © WD66140